

“Project Management Using Earned Value”
Case Study Solution 12.1

12.1

C A S E

S

Vertical and

Horizontal

Schedule Traceability

T

U

D

Y

Vertical and Horizontal Schedule Traceability

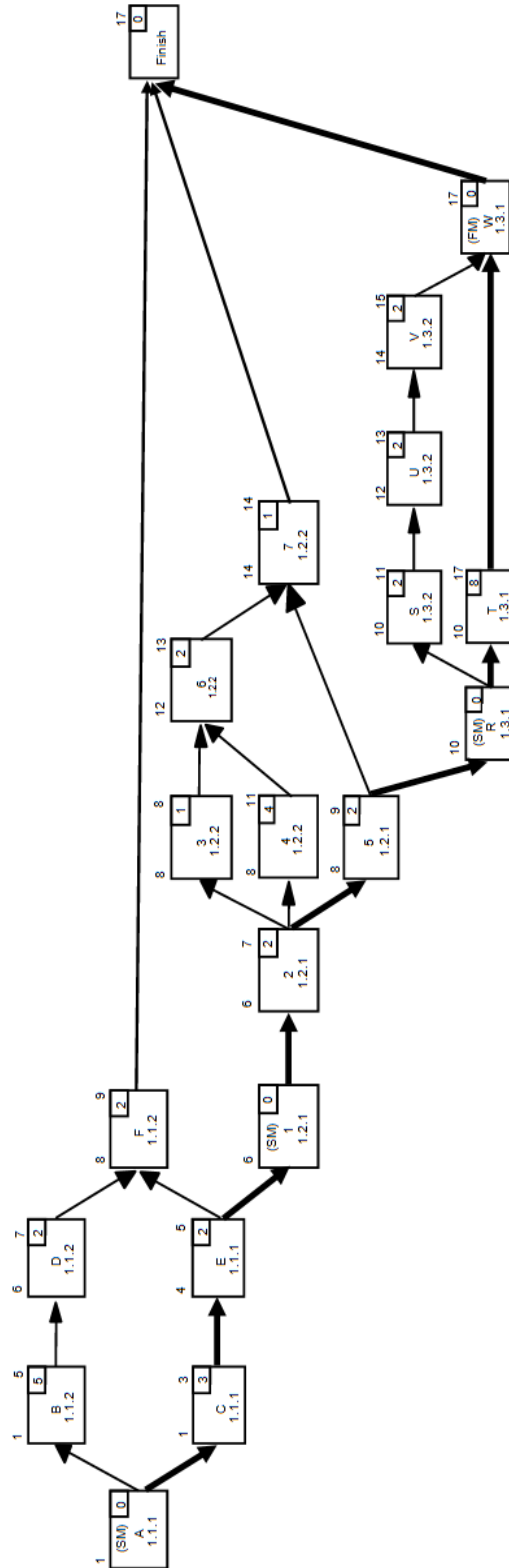

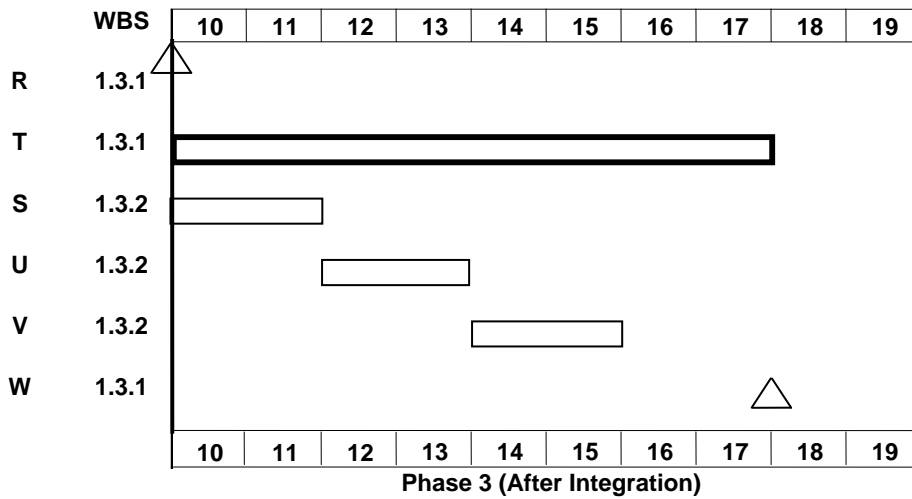
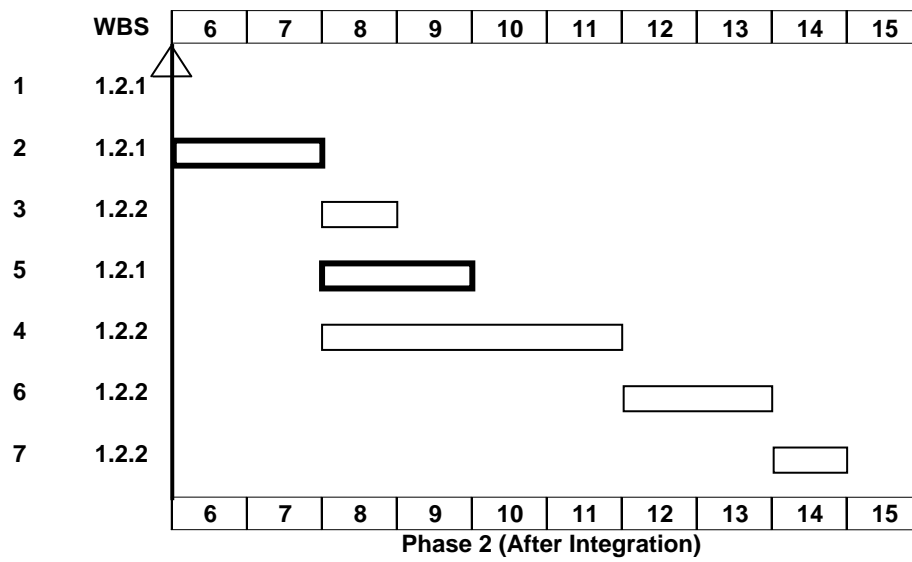
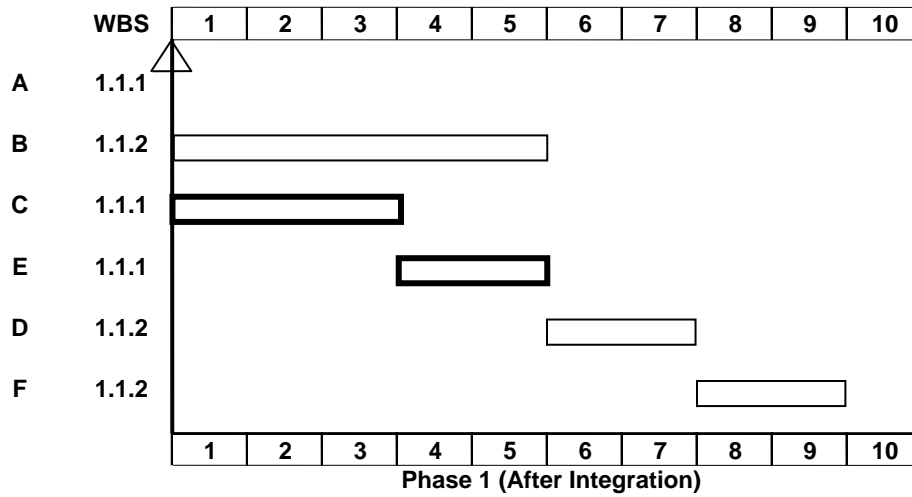

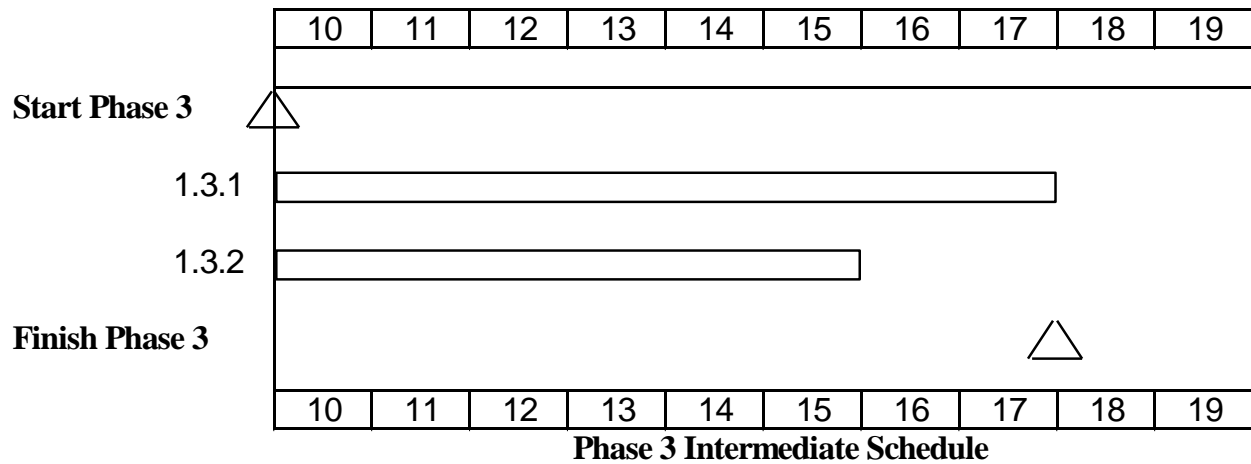
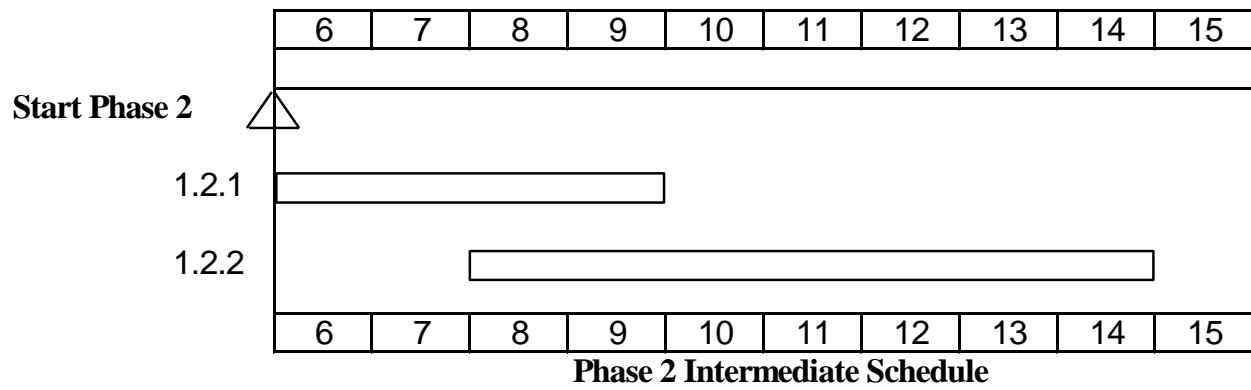
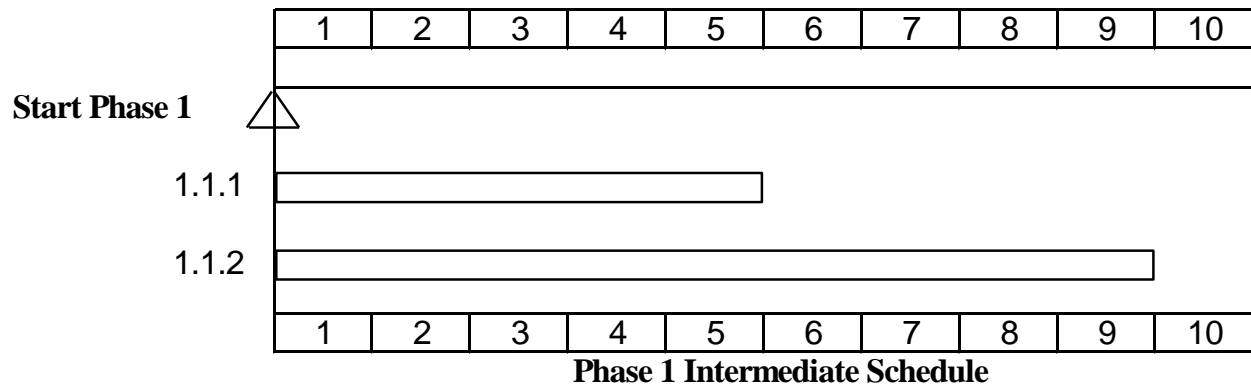

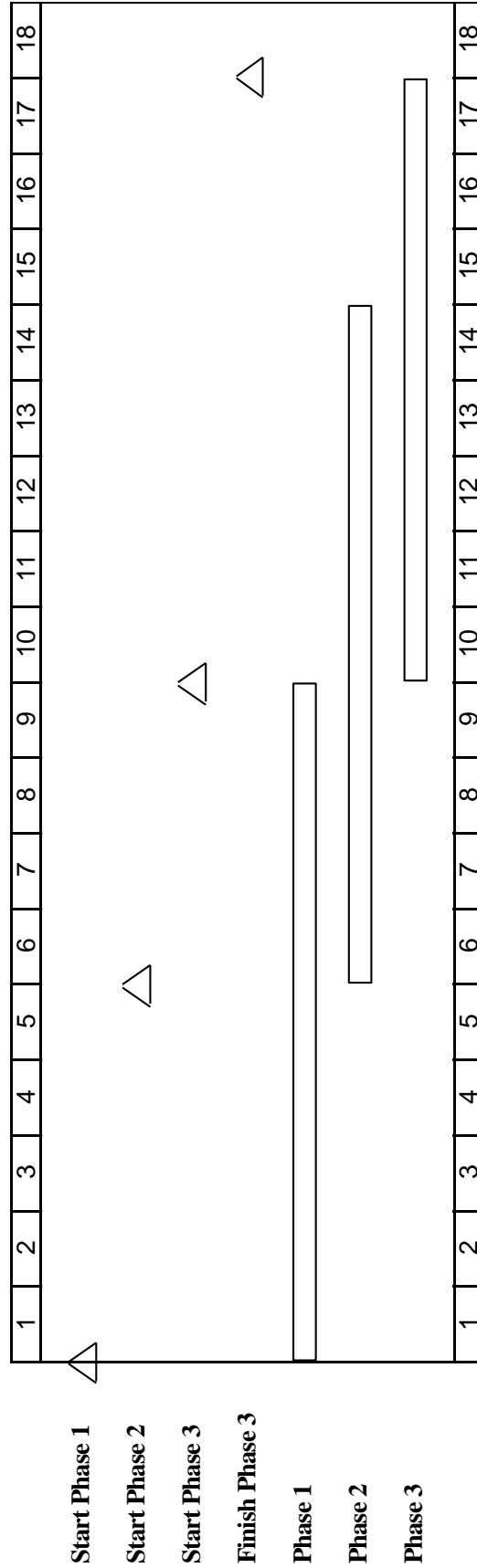

Master Schedule